

Entrée modulation TTL

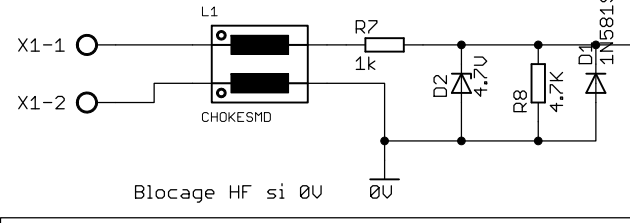

Durée impulsion réglable

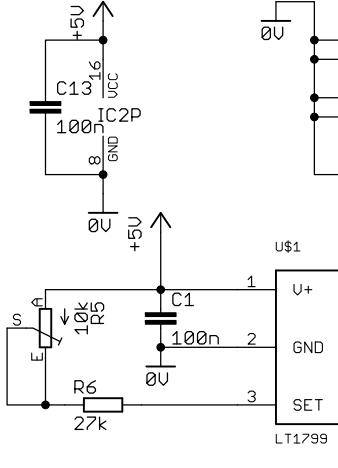
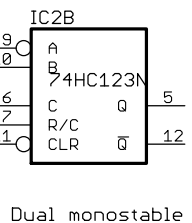
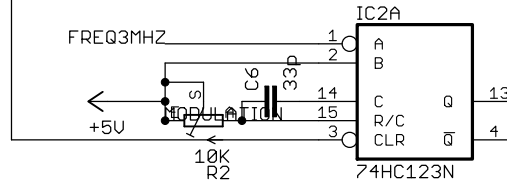

Générateur 3MHz ajustable

MODULATION

Drivers TC4422 en T0220

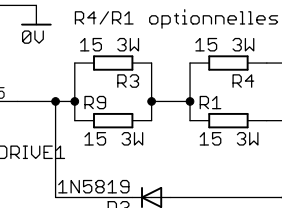
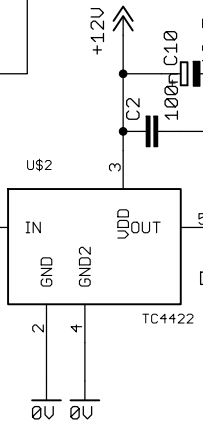

Protection du mosfet

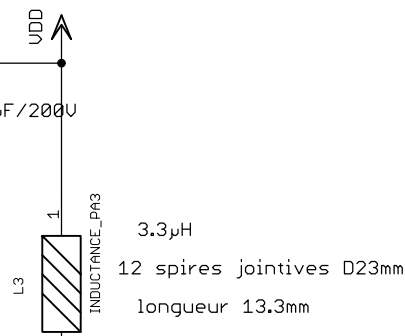
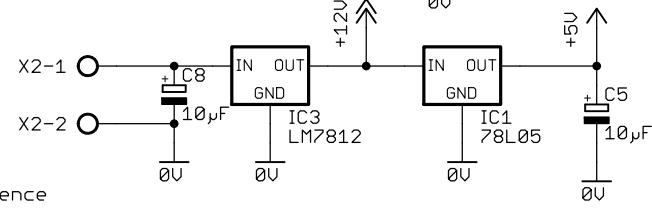

3.3µH
12 spires jointives D23mm
longueur 13.3mm

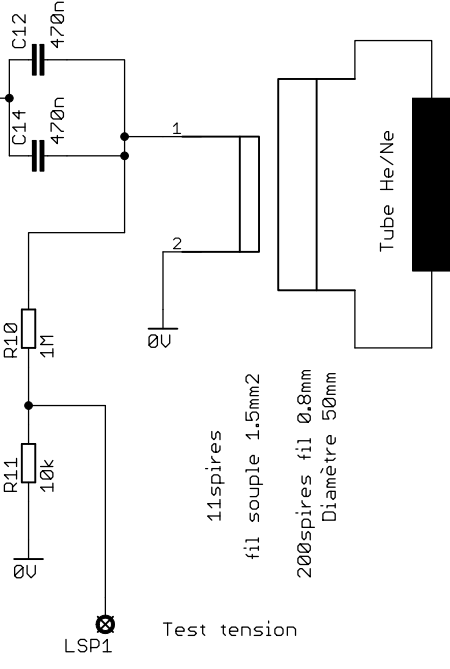

11spires
fil souple 1.5mm2
200spires fil 0.8mm
Diamètre 50mm

Test tension



TITLE: plasma_mosfets_mono

Document Number:

REV:

Date: not saved!

Sheet: 1/1